

TALÍŘE MAX | MAX PLATES

Kód | Code **Rozměr | Size**

5300xx	15 x 15 cm
5301xx	20 x 20 cm
5302xx	28 x 28 cm
5303xx	32 x 32 cm

xx - Dvojcíslní určující barvu výrobku
xx - Number of individual color

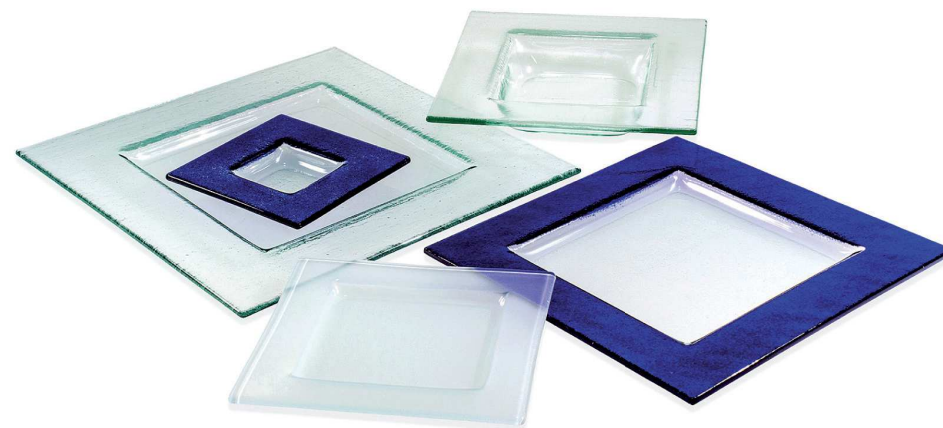

TALÍŘE BORDER | BORDER PLATES

Kód | Code **Rozměr | Size**

5091xx	13 x 13 cm
5093xx	17 x 17 cm
5095xx	21 x 21 cm hloubka depth 3 cm
5097xx	25 x 25 cm
5099xx	31 x 31 cm

xx - Dvojcíslní určující barvu výrobku
xx - Number of individual color





Nature talíře kulaté |
Nature plates str. 11



Nature talíře kulaté |
Nature plates str. 11

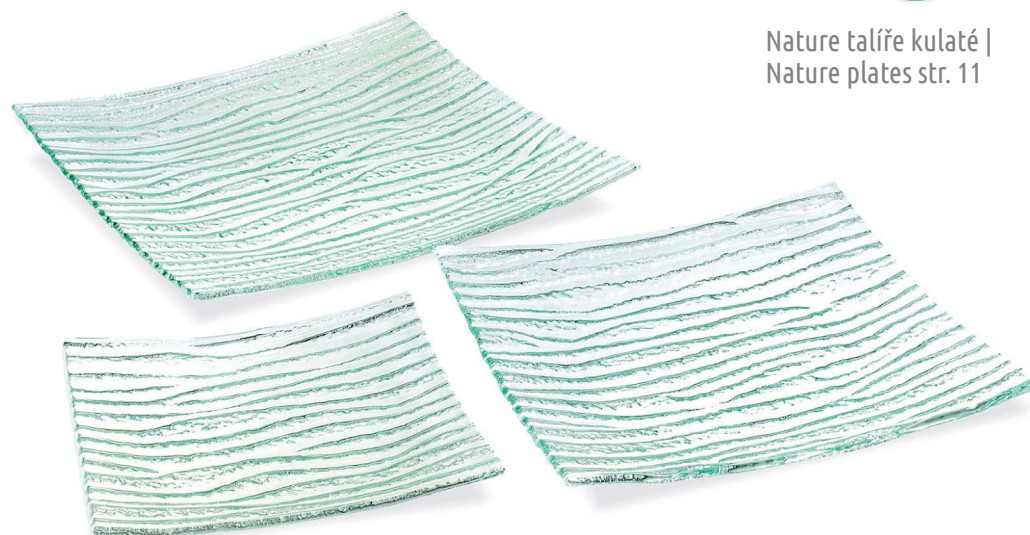

TALÍŘE NATURE | NATURE PLATES

Kód | Code Rozměr | Size

535x1y 20 x 20 cm

535x3y 27 x 27 cm

535x5y 31 x 31 cm

x - Číslice určující barvu výrobku
x - Number of individual color

y - Číslice určující strukturu výrobku
y - Number of individual structure

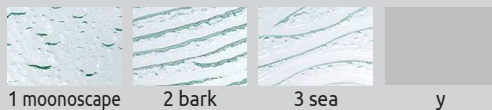
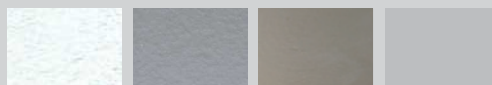

TALÍŘE NATURE | NATURE PLATES

Kód | Code Rozměr | Size

535x1y 20 x 20 cm

535x3y 27 x 27 cm

535x5y 31 x 31 cm

x - Číslice určující barvu výrobku
x - Number of individual color

y - Číslice určující strukturu výrobku
y - Number of individual structure

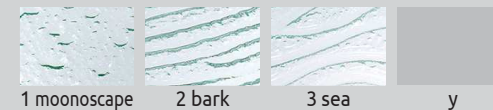
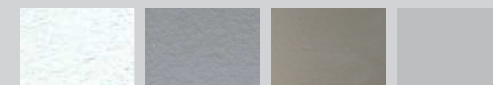





Cubo mísy | bowls str. 34

TALÍŘE SAFARI | SAFARI PLATES

TALÍŘE CUBO | CUBO PLATES

Kód Code	Rozměr Size
 5280xx	13 x 13 cm
5281xx	16 x 16 cm
5282xx	20 x 20 cm
5283xx	25 x 25 cm
5285xx	31 x 31 cm
 5284xx	29 x 29 cm hloubka depth 5 cm

xx - Dvojcísle určující barvu výrobku
xx - Number of individual color



Kód Code	Rozměr Size
5252x0	10 x 10 cm
5252x2	20 x 20 cm
5252x4	25 x 25 cm
5252x6	28 x 28 cm

x - Číslice určující barvu výrobku
x - Number of individual color

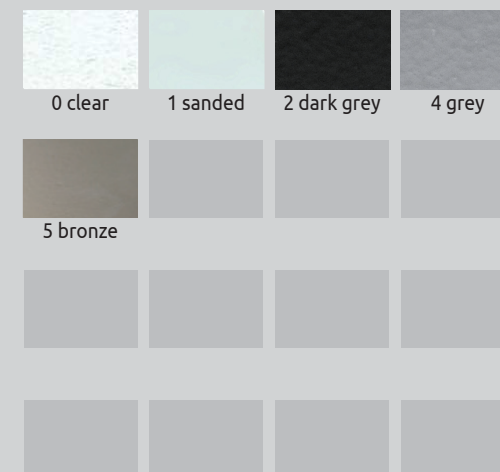



TALÍŘE BAND | BAND PLATES

Kód | Code **Rozměr | Size**

5061xx	ø 13 cm
5062xx	ø 20 cm
5064xx	ø 26 cm
5066xx	ø 32 cm
5068xx	ø 40 cm

xx - Dvojcíslný určující barvu výrobku
xx - Number of individual color



TALÍŘE FLASH | FLASH PLATES

Kód | Code **Rozměr | Size**

54460xx	ø 11 cm
54465xx	ø 32 cm

xx - Dvojcíslný určující barvu výrobku
xx - Number of individual color

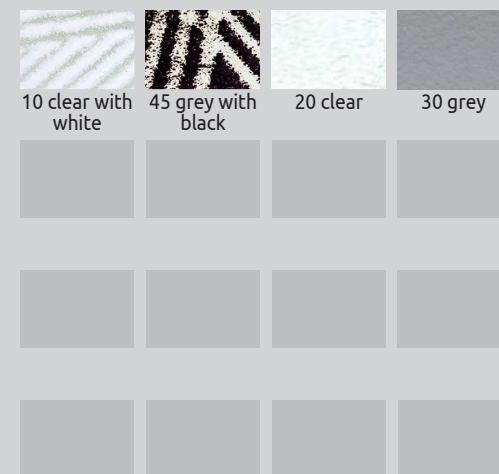



TALÍŘE CAKE | CAKE PLATES

Kód | Code **Rozměr | Size**

50730xx ø 16 cm

50733xx ø 28 cm

50736xx ø 33 cm

xx - Dvojčíslí určující barvu výrobku
xx - Number of individual color



TALÍŘE BUBBLE | BUBBLE PLATES

MĚLKÉ TALÍŘE | SHALLOW PLATES

Kód | Code **Rozměr | Size**

52042xx ø 20 cm

52012xx ø 28 cm

52032xx ø 31 cm

HLUBOKÉ TALÍŘE | DEEP PLATES

Kód | Code **Rozměr | Size**

52052xx ø 17 cm

52022xx ø 26 cm



52062xx ø 31 cm

xx - Dvojčíslí určující barvu výrobku
xx - Number of individual color







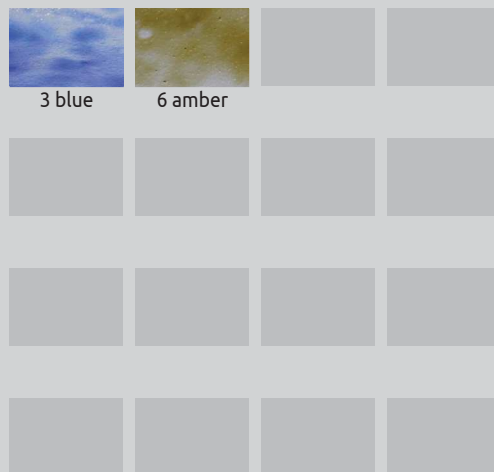

TALÍŘE COUNTRY I. | COUNTRY I. PLATES

Kód Code	Rozměr Size
 5473022x ø 20 cm	
5473222x ø 28 cm	
 5473422x ø 25 cm	
5473522x ø 29 cm	

x - Číslice určující barvu výrobku
x - Number of individual color



TALÍŘE COUNTRY II. | COUNTRY II. PLATES

Kód Code	Rozměr Size
 5471020xx ø 20 cm	
5471220xx ø 28 cm	
5471420xx ø 33 cm	
 5471120xx ø 25 cm	
 5471320xx ø 28 cm	
 5471520xx ø 29 cm	

xx - Dvojcíslicí určující barvu výrobku
xx - Number of individual color





Nature talíře čtvercové |
Nature plates str. 6

Nature talíře čtvercové |
Nature plates str. 6



TALÍŘE MELODY | MELODY PLATES

TALÍŘE NATURE | NATURE PLATES

Kód | Code Rozměr | Size

54471xx	ø 13 cm
54473xx	ø 21 cm
54475xx	ø 25 cm
54477xx	ø 33 cm

xx - Dvojcísle určující barvu výrobku
xx - Number of individual color



Kód | Code Rozměr | Size

535x1y	ø 21 cm
535x3y	ø 28 cm
535x5y	ø 35 cm

x - Číslice určující barvu výrobku
x - Number of individual color

y - Číslice určující strukturu výrobku
y - Number of individual structure

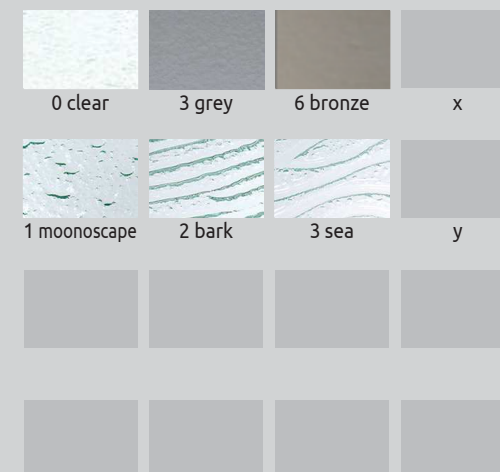



Etažér | Cake 3-storey
whatnot - str. 50





Etažér |
Cake whatnot - str. 49



TALÍŘE VELO | VELO PLATES

Kód | Code Rozměr | Size



	55134xx	ø 20 cm
	55138xx	ø 28 cm
	55132xx	ø 18 cm
	55136xx	ø 23 cm

xx - Dvojčíslí určující barvu výrobku
xx - Number of individual color



TALÍŘE STUMP | STUMP PLATES

Kód | Code Rozměr | Size

	55102xx	ø 20 cm
	55106xx	ø 28 cm
	55104xx	ø 24 cm





xx - Dvojčíslí určující barvu výrobku
xx - Number of individual color





TALÍŘE COUNTRY III. | COUNTRY III. PLATES

TALÍŘE COUNTRY IV. | COUNTRY IV. PLATES





Kód Code	Rozměr Size
 547202xy ø 20 cm	
 547222xy ø 28 cm	
 547242xy ø 25 cm	
 547252xy ø 29 cm	

x - Číslice určující barvu okraje
x - Number of rim color

y - Číslice určující barvu výrobku
y - Number of individual color



další barevné varianty - viz. vzorník barev - str. 66
another color variations can be found in the color swatch - p. 66

Kód Code	Rozměr Size
 547203xx ø 20 cm	
 547223xx ø 28 cm	
 547243xx ø 25 cm	
 547253xx ø 29 cm	

xx - Dvojcíslicí určující barvu výrobku
xx - Number of individual color

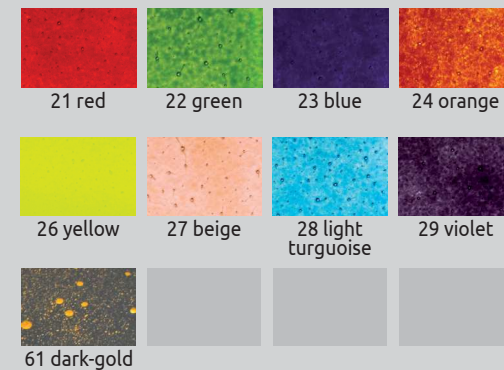

další barevné varianty - viz. vzorník barev - str. 66
another color variations can be found in the color swatch - p. 66





Talíře ANTIQUE I
ANTIQUÉ Plates str. 15





Tácy ANTIQUE I
ANTIQUÉ Trays str. 25



Oval Ella II. talíře | Oval
Ella II. plates - str. 17



TALÍŘE ANTIQUE | ANTIQUÉ PLATES

Kód Code	Rozměr Size
 5056101	ø 15 cm
5056111	ø 20 cm
5056131	ø 28 cm
5056161	ø 33 cm
 5056141	ø 28 cm
 5056181	ø 25 cm
5056191	ø 29 cm



KULATÉ TALÍŘE ELLA | ROUND ELLA PLATES

Kód Code	Rozměr Size
547202xx	ø 20 cm
547222xx	ø 28 cm
547232xx	ø 28 cm hluboký deep

xx - Dvojičíslo určující barvu ráfku
xx - Number of rim color





TALÍŘE OLYMPIA | OLYMPIA PLATES

Kód | Code **Rozměr | Size**

51552xx 26 x 11 cm

51554xx 33 x 14 cm

xx - Dvojčíslí určující barvu výrobku
xx - Number of individual color



Talíře ANTIQUE I
ANTIQUÉ Plates str. 14

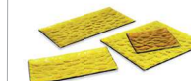

Tácky ANTIQUE I
ANTIQUÉ Trays str. 25



TALÍŘE ANTIQUE | ANTIQUE PLATES

Kód | Code **Rozměr | Size**

5056311 20 x 14 cm

5056331 30 x 23 cm

5056351 34 x 26 cm





TALÍŘE AMEBA I. | AMEBA I. PLATES

Kód | Code **Rozměr | Size**

5360xx	19 x 15 cm
5362xx	24 x 19 cm
5364xx	29 x 24 cm
5366xx	40 x 24 cm

xx - Dvojcíslní určující barvu výrobku
xx - Number of individual color



TALÍŘE AMEBA II. | AMEBA II. PLATES

Kód | Code **Rozměr | Size**

5376xx	25 x 18 cm
5370xx	26 x 28 cm
5372xx	37 x 30 cm
5374xx	38 x 28 cm

xx - Dvojcíslní určující barvu výrobku
xx - Number of individual color





TALÍŘE OVAL ELLA | OVAL ELLA PLATES

Kód | Code **Rozměr | Size**

51571xx 20 x 14 cm

51573xx 30 x 23 cm

51575xx 34 x 26 cm

xx - Dvojcíslní určující barvu výrobku
xx - Number of individual color

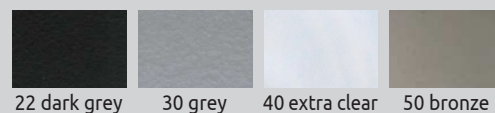

Kulaté talíře Ella | Round
Ella plates - str. 14



TALÍŘE OVAL ELLA II. | OVAL ELLA II. PLATES

Kód | Code **Rozměr | Size**

51571xx 20 x 14 cm

51573xx 30 x 23 cm

51575xx 34 x 26 cm

xx - Dvojcíslní určující ráfek výrobku
xx - Number of rim color





TÁCY | TRAYS
Trays *Tácy*



Obdelníkové tácy ZOOM I. I ZOOM I. Trays str. 24



Tácy ZOOM II. I ZOOM II. Trays str. 29



Kulaté tácy ZOOM I Round ZOOM Trays str. 28



Servírovací tácy I SERVING Trays str. 26



ČTVERCOVÉ TÁCY ZOOM | ZOOM SQUARE TRAYS

SERVÍROVACÍ TÁCY | SERVING TRAYS

Kód | Code Rozměr | Size

54511xx	15 x 15 cm
54513xx	20 x 20 cm
54515xx	26 x 26 cm
54517xx	32 x 32 cm

xx - Dvojcísli určující barvu výrobku
xx - Number of individual color

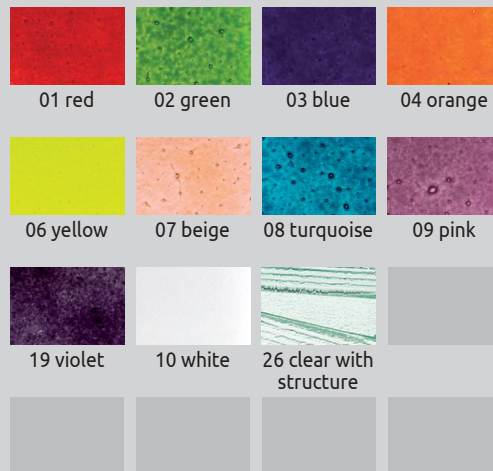

Kód | Code Rozměr | Size

5400xx	40 x 40 cm
--------	------------

xx - Dvojcísli určující barvu výrobku
xx - Number of individual color





TÁČY STONES | STONES TRAYS

Kód Code	Rozměr Size
54301xx	26 x 15 cm
54303xx	30 x 22 cm
54304xx	30 x 30 cm
54305xx	45 x 30 cm

xx - Dvojcíslní určující barvu výrobku
xx - Number of individual color

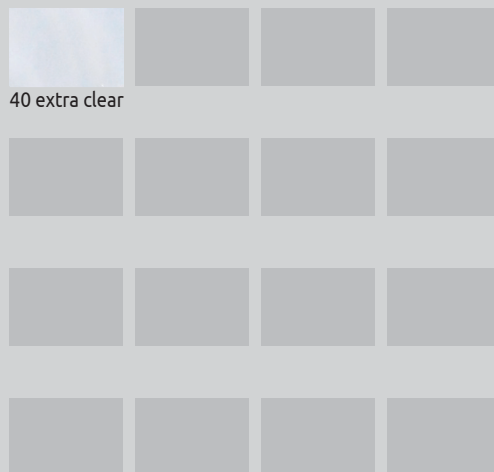

TÁČY BOND | BOND TRAYS

Kód Code	Rozměr Size
54351xx	13 x 13 cm
54353xx	20 x 20 cm
54355xx	33 x 16 cm
54357xx	45 x 20 cm

xx - Dvojcíslní určující barvu výrobku
xx - Number of individual color

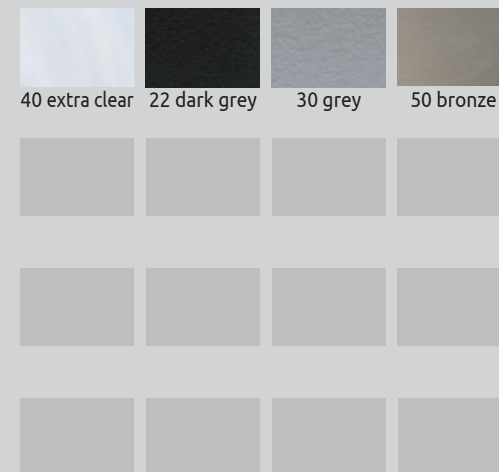



TÁČY MAXIM | MAXIM TRAYS

Kód | Code **Rozměr | Size**

53131xx	23 x 13 cm
53135xx	25 x 25 cm
53132xx	29 x 15 cm
53134xx	29 x 23 cm
53133xx	32 x 12 cm

xx - Dvojcíslní určující barvu výrobku
xx - Number of individual color



TÁČY LED | LED TRAYS

Kód | Code **Rozměr | Size**

	56036x5	22 x 22 cm
	56036x4	24 x 10 cm
	56036x2	26 x 10 cm
	56036x6	28 x 13 cm
	56036x1	34 x 10 cm
	56036x3	22 x 22 cm

x - Číslice určující barvu výrobku
x - Number of individual color







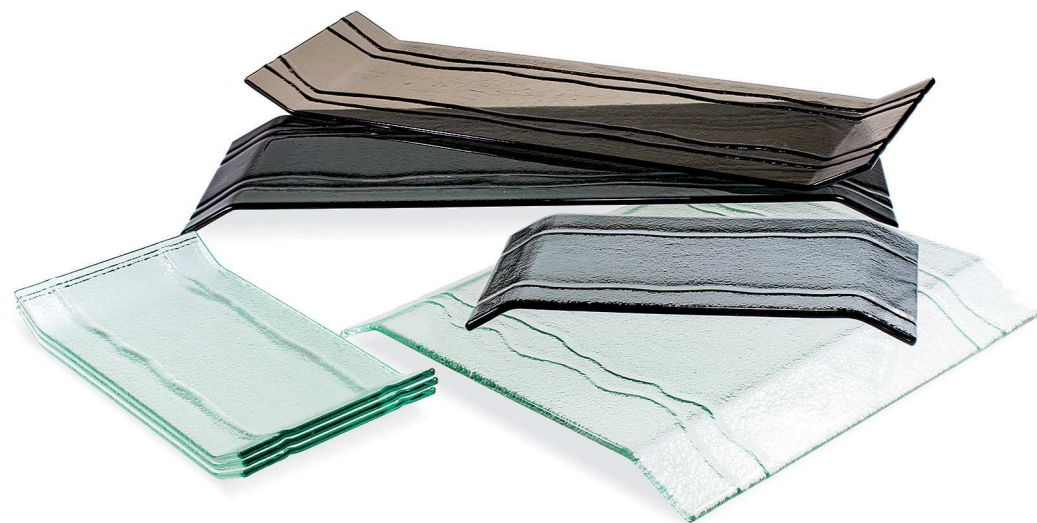

Mísy POCKET |
POCKET Bowls - str. 32



TÁCKY POCKET | POCKET TRAYS

Kód Code	Rozměr Size
 512x48	10 x 10 cm
512x04	13 x 13 cm
512x49	12 x 12 cm
512x34	14 x 14 cm
 512x05	23 x 13
 512x06	34 x 13 cm
 512x29	45 x 13 cm

x - Číslice určující barvu výrobku
x - Number of individual color

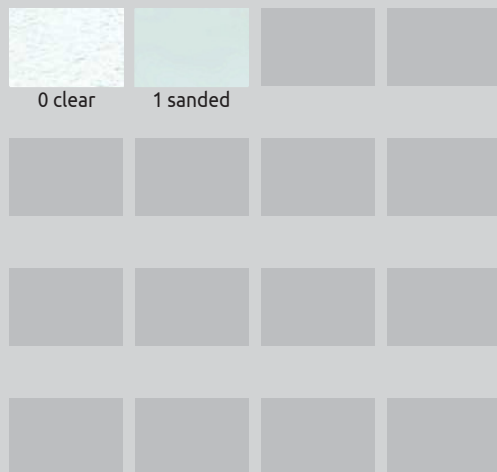

TÁČY BRIDGE | BRIDGE TRAYS

Kód Code	Rozměr Size
54111xx	24 x 12 cm
54113xx	28 x 28 cm
54112xx	45 x 15 cm

xx - Dvojcíslicí určující barvu výrobku
xx - Number of individual color

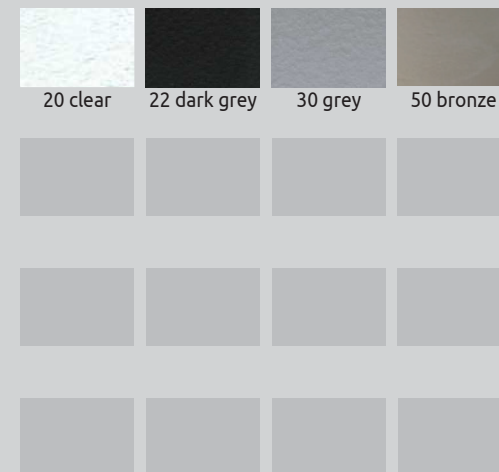



GN TÁCY | GN TRAYS (GASTRONORM)

Kód | Code **Rozměr | Size**

54611xx	10,8 x 17,6 cm
54612xx	17,6 x 16,2 cm
54613xx	26,5 x 16,3 cm
54614xx	32,5 x 17,6 cm
54615xx	32,5 x 26,5 cm
54616xx	35,4 x 32,5 cm
54617xx	53 x 32,5 cm

xx - Dvojcíslní určující barvu výrobku
xx - Number of individual color

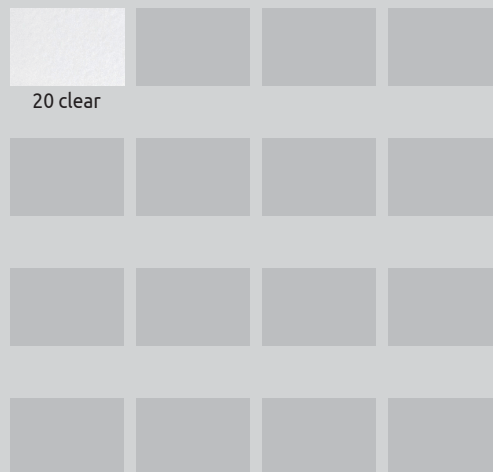

GN BAREVNÉ TÁCY | GN COLOR TRAYS

Kód | Code **Rozměr | Size**

5402xx	53 x 32,5 cm
--------	--------------

xx - Dvojcíslní určující barvu výrobku
xx - Number of individual color

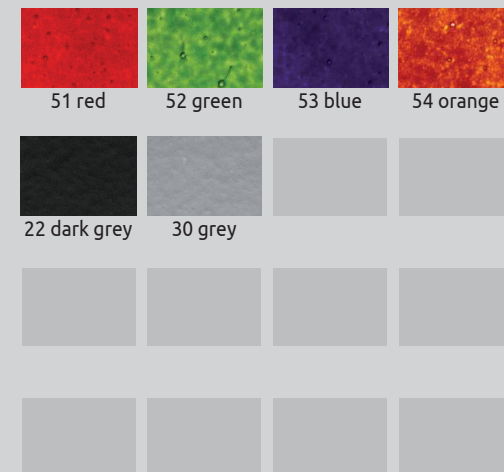

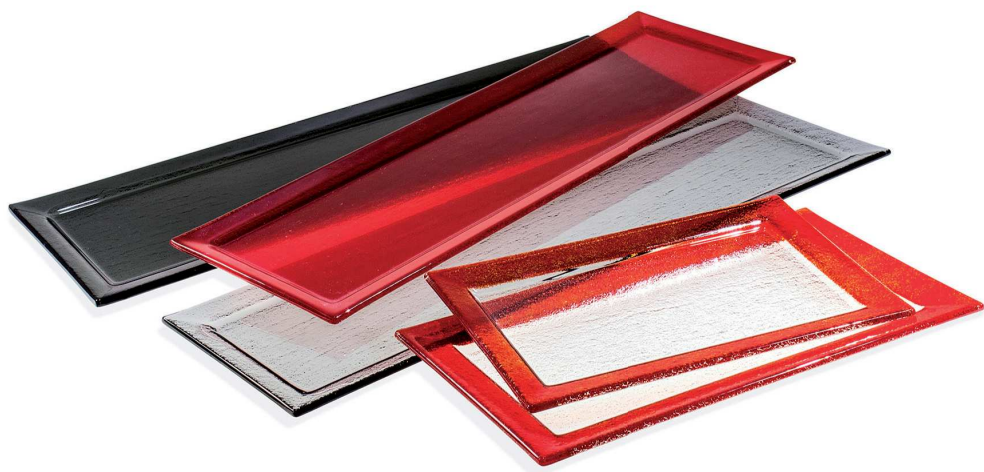

Čtvercové tácy ZOOM
I Square ZOOM Trays
str. 19



Tácy ZOOM Eye I ZOOM
Eye Trays str. 29



Kulaté Tácy ZOOM I
Round ZOOM Trays str. 28



PODNOŠY MAX GN | MAX GN TRAYS

JEDNOBAREVNÉ | FULLCOLORED

Kód | Code **Rozměr | Size**

53113xx 26,5 x 16,3 cm

53114xx 32,5 x 17,6 cm

53118xx 53 x 16,2 cm

BAREVNÝ OKRAJ | COLORED RIM

Kód | Code **Rozměr | Size**

53123xx 26,5 x 16,3 cm

53124xx 32,5 x 17,6 cm

53128xx 53 x 16,2 cm

xx - Dvojcíslní určující barvu výrobku
xx - Number of individual color



01 red 02 green 17 brown 19 violet



09 pink 10 white



JEDNOBAREVNÉ | ONLY FULL COLOR VERSION

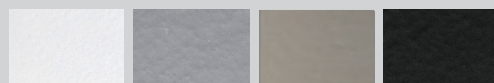

20 clear 30 grey 50 bronze 22 dark grey

OBDELNÍKOVÉ TÁCY ZOOM | ZOOM TRAYS

Kód | Code **Rozměr | Size**

54523xx 30 x 15 cm

54525xx 40 x 17 cm

54526xx 45 x 20 cm

xx - Dvojcíslní určující barvu výrobku
xx - Number of individual color



01 red 02 green 03 blue 04 orange



06 yellow 07 beige 08 turquoise 09 pink



19 violet 10 white 26 clear with structure





TÁČY LONG | LONG TRAYS

Kód | Code **Rozměr | Size**

51901xx	31 x 13 cm
51905xx	45 x 20 cm
51902xx	49 x 13 cm
51904xx	53 x 16 cm
51903xx	59 x 13 cm

xx - Dvojčíslí určující barvu výrobku
xx - Number of individual color

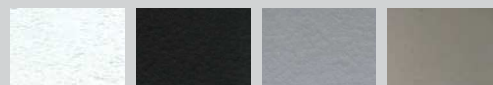

20 clear 22 dark grey 30 grey 50 bronze



Talíře ANTIQUE I
ANTIQUÉ Plates str. 14



Talíře ANTIQUE I
ANTIQUÉ Plates str. 15

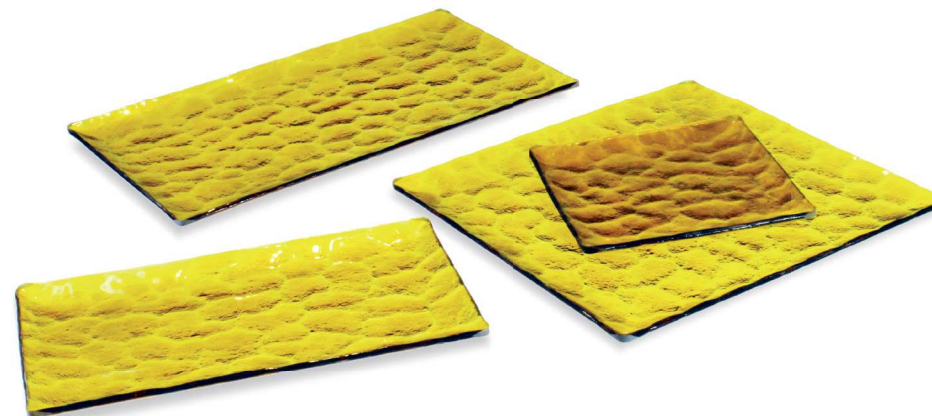

TÁČY ANTIQUE | ANTIQUÉ TRAYS

Kód | Code **Rozměr | Size**

5056211	14,5 x 14,5 cm
5056231	24,5 x 14,5 cm
5056241	31 x 17,5 cm
5056261	24,5 x 24,5 cm



amber





Servírovací tácy I
SERVING Trays str. 21



SERVÍROVACÍ TÁCY | SERVING TRAYS

Kód | Code **Rozměr | Size**

5400xx 50 x 35 cm

xx - Dvojičísíí určující strukturu výrobku
xx - Number of structure



03

04



TÁCY CASTLE | CASTLE TRAYS

Kód | Code **Rozměr | Size**

54343xx 38 x 18 cm

54345xx 48 x 24 cm

xx - Dvojičísíí určující barvu výrobku
xx - Number of individual color



20 clear

40 extra clear





TÁČY CHOCOLATE | CHOCOLATE TRAYS

TÁČY CHOCOLATE | CHOCOLATE TRAYS

Kód | Code **Rozměr | Size**

54220xx 52 x 13 cm

54221xx 52 x 20 cm

54222xx 52 x 25 cm

xx - Dvojčíslí určující barvu výrobku
xx - Number of individual color

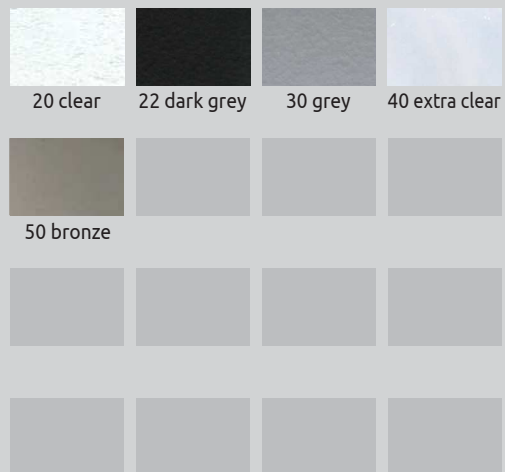

Kód | Code **Rozměr | Size**

54223xx 41 x 41 cm

xx - Dvojčíslí určující barvu výrobku
xx - Number of individual color

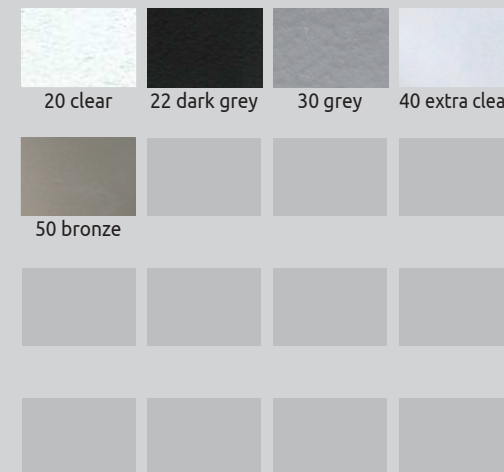



Čtvercové tácy ZOOM
I ZOOM Square Trays
str. 19



Obdelníkové tácy ZOOM
I ZOOM II. Trays str. 24



Tácy ZOOM EYE I ZOOM
EYE Trays str. 29



TÁCY TREBLE | TREBLE TRAYS

Kód | Code **Rozměr | Size**

54333xx ø 31 cm

54331xx 35 x 20 cm

xx - Dvočíslí určující barvu výrobku
xx - Number of individual color



KULATÉ TÁCY ZOOM | ROUND ZOOM TRAYS

Kód | Code **Rozměr | Size**

54501xx ø 16 cm

54503xx ø 22 cm

54504xx ø 25 cm | hloubka
depth 4 cm

54505xx ø 30 cm

54507xx ø 36 cm

xx - Dvočíslí určující barvu výrobku
xx - Number of individual color

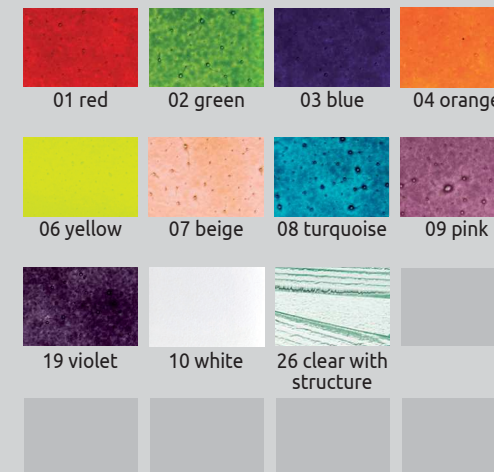



Čtvercové tácy ZOOM I
Square ZOOM Trays
str. 19



Obdelníkové tácy ZOOM I
ZOOM II. Trays str. 24



Kulaté tácy ZOOM I
Round ZOOM Trays str. 28



TÁCY ZOOM EYE | ZOOM EYE TRAYS

TÁCY OVAL | OVAL TRAYS

Kód | Code Rozměr | Size

54532xx 25 x 14 cm

54535xx 35 x 20 cm

54538xx 50 x 29 cm

xx - Dvojčíslí určující barvu výrobku
xx - Number of individual color



01 red 02 green 03 blue 04 orange



06 yellow 07 beige 08 turquoise 09 pink

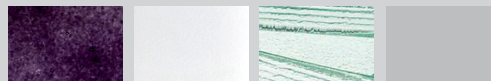

19 violet 10 white 26 clear with structure



Kód | Code Rozměr | Size

54122xx 36 x 13 cm

54123xx 48 x 18 cm

54125xx 60 x 22 cm

xx - Dvojčíslí určující barvu výrobku
xx - Number of individual color



30 grey 20 clear 26 clear with structure







MÍSY | BOWLS
Bowls *Misy*



MÍSY ORNAMENTAL | ORNAMENTAL BOWLS

Kód Code	Rozměr Size
 505x28	30 x 30 cm hluboká deep
 505x18	30 x 30 cm mělká shallow

x - Číslice určující strukturu výrobku
x - Number of structure



MÍSY PROLIS | PROLIS BOWLS

Kód Code	Rozměr Size
54231xx	12 x 12 cm
54233xx	20 x 20 cm
54235xx	25 x 25 cm
54237xx	30 x 30 cm
54239xx	38 x 38 cm

xx - Dvojčíslí určující barvu výrobku
xx - Number of individual color



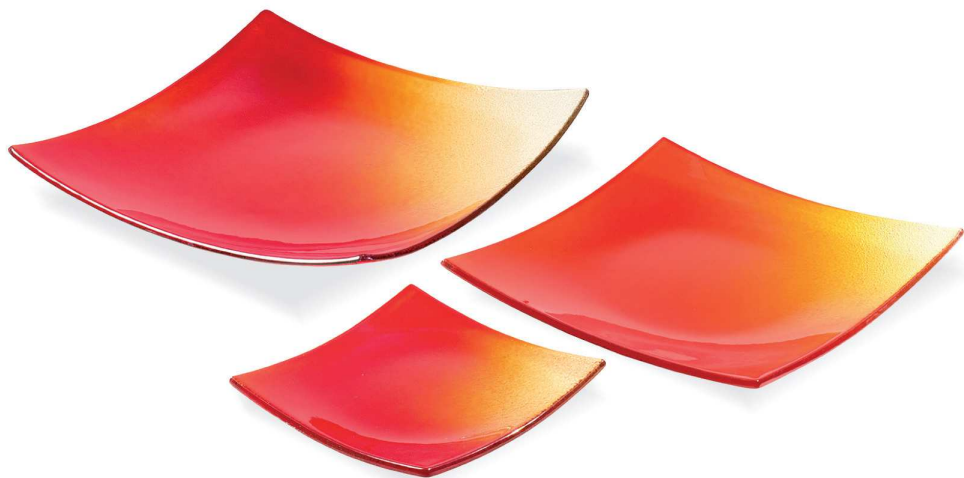

Tácy POCKET |
POCKET Trays - str. 22





MÍSY MATIZ | MATIZ BOWLS

Kód Code	Rozměr Size
5040xx	15 x 15 cm
5042xx	23 x 23 cm
5041xx	30 x 30 cm

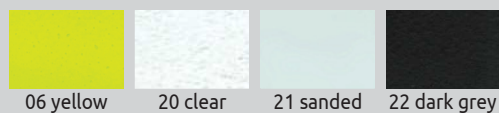
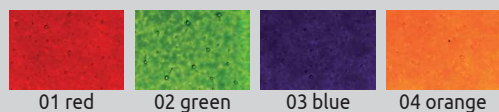
xx - Dvojcíslný určující barvu výrobku
xx - Number of individual color



MÍSY POCKET | POCKET BOWLS

Kód Code	Rozměr Size
 55053xx	23 x 23 x 1 cm
55051xx	26 x 26 x 1,5 cm
55054xx	26 x 26 x 3 cm
55052xx	30 x 30 cm x 1,5 cm
55056xx	23 x 23 x 3 cm
 55055xx	26 x 26 x 1,5 cm

xx - Dvojcíslný určující barvu výrobku
xx - Number of individual color

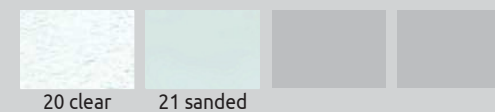



MÍSY SALAD III. | SALAD III. BOWLS

Kód Code	Rozměr Size
55441xx	14 x 14 cm hluboká 4 cm depth 4 cm
55442xx	19 x 19 cm hluboká 5 cm depth 5 cm

xx - Dvojčíslí určující barvu výrobku
xx - Number of individual color



MÍSY SWING | SWING BOWLS

Kód Code	Rozměr Size
54101xx	28 x 28 cm
54102xx	43 x 20 cm
54103xx	60 x 24 cm

xx - Dvojčíslí určující barvu výrobku
xx - Number of individual color

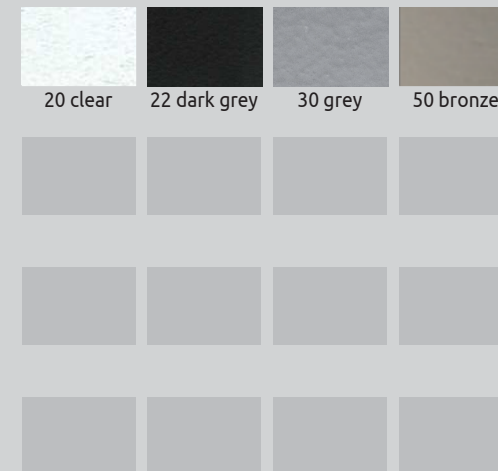

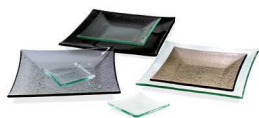

Cubo talíře |
Cubo plates str. 7

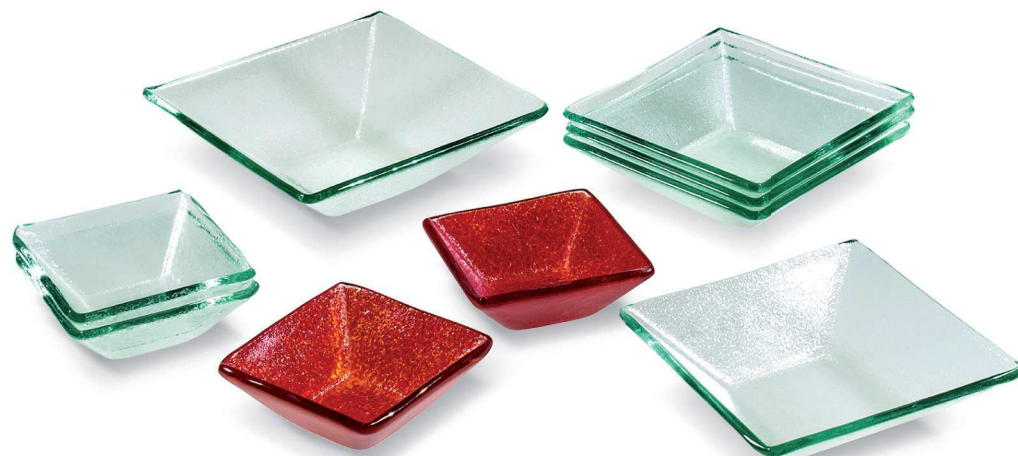

MÍSY CUBO | CUBO BOWLS

Kód | Code Rozměr | Size

5252x7 23 x 23 cm

5252x8 26 x 26 cm

5252x9 29 x 29 cm

x - Číslice určující barvu výrobku
x - Number of individual color

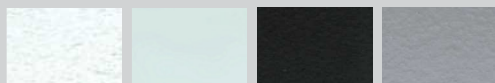

MÍSY SALAD I. | SALAD I. BOWLS

Kód | Code Rozměr | Size

53352xx 9 x 9 cm hluboká 3,5 cm
| depth 3,5 cm

55431xx 13 x 13 cm hluboká 3,5 cm
| depth 3,5 cm

55432xx 15 x 15 cm hluboká 4,5 cm
| depth 4,5 cm

xx - Dvojcíslicí určující barvu výrobku
xx - Number of individual color





MÍSY TUBE LINKY | TUBE LINKY BOWLS

Kód | Code Rozměr | Size

54312xx 30 x 18 cm

54315xx 42 x 18 cm

54313xx 45 x 13 cm

xx - Dvojčíslí určující barvu výrobku
xx - Number of individual color

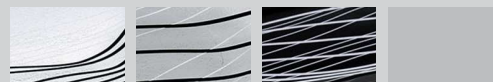

29 extra clear
with black and
silver lines

49 grey with
black and
silver lines

69 dark grey
with white
lines



MÍSY TUBE | TUBE BOWLS

Kód | Code Rozměr | Size

54312xx 30 x 17 cm

54313xx 45 x 13 cm

54315xx 45 x 20 cm

54317xx 48 x 23 cm

xx - Dvojčíslí určující barvu výrobku
xx - Number of individual color

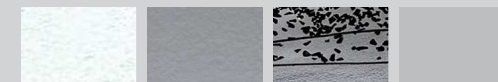

20 clear

30 grey

45 grey
with black





MÍSY KAMENY | KAMENY BOWLS

Kód | Code **Rozměr | Size**

56034x2	13 x 13 cm
56034x3	19 x 11 cm
56034x7	23 x 17 cm
56034x8	23 x 23 cm
56034x9	36 x 17 cm

x - Číslice určující barvu výrobku
x - Number of individual color

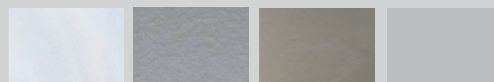

0 extra clear 2 grey 3 bronze



MÍSY VALENCE | VALENCE BOWLS

Kód | Code **Rozměr | Size**

51520xx	42 x 22 cm
---------	------------

xx - Dvojcíslicí určující barvu výrobku
xx - Number of individual color

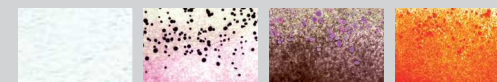

20 clear 09 pink 19 violet 01 red

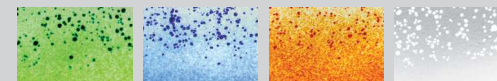

02 green 03 blue 04 orange 10 white





MÍSY PASTA | PASTA BOWLS

Kód | Code Rozměr | Size

54246xx ø 29 cm

xx - Dvojcísli určující barvu výrobku
xx - Number of individual color



MÍSY KISS | KISS BOWLS

Kód | Code Rozměr | Size

54451xx ø 9,5 cm

54453xx ø 16 cm

54455xx ø 20 cm

54457xx ø 32 cm

xx - Dvojcísli určující barvu výrobku
xx - Number of individual color

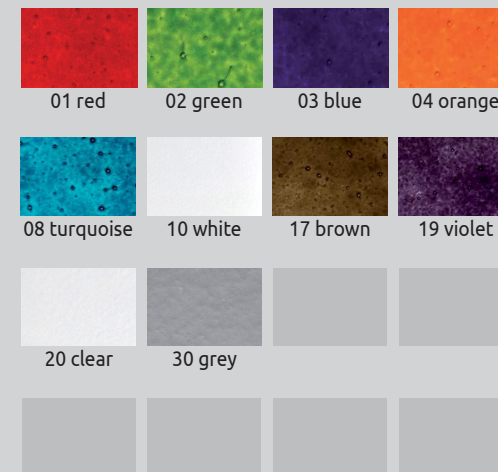



MÍSY LEAF | LEAF BOWLS

Kód | Code **Rozměr | Size**

5150xxx 47 x 19 cm

xxx - Trojčíslí určující barvu výrobku
xxx - Number of individual color

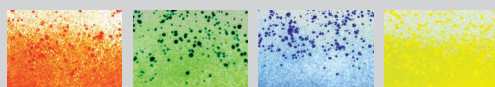

101 red 102 green 103 blue 106 yellow



109 violet 110 white 001 red 002 green



003 blue 006 yellow 020 clear 021 sanded



MÍSY PEARL | PEARL BOWLS

Kód | Code **Rozměr | Size**

 54401xx ø 15 cm

54403xx ø 18 cm

54405xx ø 32 cm

54407xx ø 36 cm

 54411xx ø 15 cm | 3 cm

54413xx ø 18 cm | 3 cm

54415xx ø 32 cm | 3 cm

54417xx ø 36 cm | 4,5 cm

xx - Dvočíslí určující barvu výrobku
xx - Number of individual color



01 red 02 green 03 blue 04 orange



06 yellow 08 turquoise 09 pink 10 white



19 violet 20 clear





MÍSY SOLO | SOLO BOWLS

Kód | Code **Rozměr | Size**

243700xx ø 42 cm
hloubka 11 cm
depth 11 cm

243701xx ø 35 cm
hloubka 8,5 cm
depth 8,5 cm

243702xx ø 53 cm
hloubka 15 cm
depth 15 cm

xx - Dvojičísí určující barvu výrobku
xx - Number of individual color

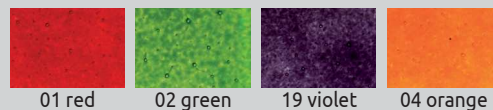

MÍSY CLOD | CLOD BOWLS

Kód | Code **Rozměr | Size**

55150xx 20 x 12 cm

xx - Dvojičísí určující barvu výrobku
xx - Number of individual color

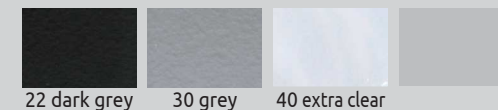



SCHODY A ETAŽÉRY | STEP TRAYS

Step trays

Etažéry



RAUTOVÉ SCHODY I. | STEPS I. TRAYS

Kód | Code **Rozměr | Size**

5540018 67 x 40 x 12 cm
4 stupně | 4 stairs

K rautovým schodům nabízíme skleněné podpěry podle velikosti schodů. Pro bližší informace nás prosím kontaktujte.

For STEPS Trays we also offer special glass supports according to the size of product. We can send further informations on request.



Podpěru je nutné doobjednat zvlášť.
Support must be ordered separately.

RAUTOVÉ SCHODY I. | STEPS I. TRAYS

Kód | Code **Rozměr | Size**

5540418 67 x 40 x 12 cm
4 stupně | 4 stairs

K rautovým schodům nabízíme skleněné podpěry podle velikosti schodů. Pro bližší informace nás prosím kontaktujte.

For STEPS Trays we also offer special glass supports according to the size of product. We can send further informations on request.



Podpěru je nutné doobjednat zvlášť.
Support must be ordered separately.





RAUTOVÉ SCHODY I. | STEPS I. TRAYS

Kód | Code **Rozměr | Size**

540019 65 x 40 x 20 cm
7 stupňů | 7 stairs

K rautovým schodům nabízíme skleněné podpěry podle velikosti schodů. Pro bližší informace nás prosím kontaktujte.

For STEPS Trays we also offer special glass supports according to the size of product. We can send further informations on request.



Podpěru je nutné doobjednat zvlášť.
Support must be ordered separately.

RAUTOVÉ SCHODY I. | STEPS I. TRAYS

Kód | Code **Rozměr | Size**

540419 65 x 40 x 20 cm
7 stupňů | 7 stairs

K rautovým schodům nabízíme skleněné podpěry podle velikosti schodů. Pro bližší informace nás prosím kontaktujte.

For STEPS Trays we also offer special glass supports according to the size of product. We can send further informations on request.



Podpěru je nutné doobjednat zvlášť.
Support must be ordered separately.



RAUTOVÉ SCHODY PYRAMIDA | PYRAMIDA TRAYS

TÁCKY CANAPÉ I. | CANAPÉ TRAYS I.

Kód | Code Rozměr | Size

540x40 40 x 40 cm

x - Číslice určující barvu výrobku
x - Number of individual color

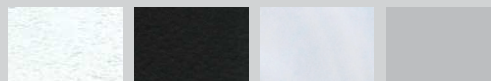

0 clear 4 dark grey 5 extra clear

K rautovým schodům nabízíme skleněné podpěry podle velikosti schodů. Pro bližší informace nás prosím kontaktujte.

For STEPS Trays we also offer special glass supports according to the size of product. We can send further informations on request.



Podpěru je nutné doobjednat zvlášť.
Support must be ordered separately.

Kód | Code Rozměr | Size

50103xx 10 x 10 cm

xx - Dvojcíslice určující barvu výrobku
xx - Number of individual color



01 red 02 green 04 orange 06 yellow



07 beige 08 turquoise 09 pink 11 light green

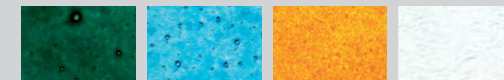

12 dark green 18 light turquoise 37 light amber 20 clear



30 grey 22 dark grey





RAUTOVÉ SCHODY II. | STEPS II. TRAYS

Kód | Code **Rozměr | Size**

540x21 88 x 48 x 10 cm

x - Číslice určující barvu výrobku
x - Number of individual color

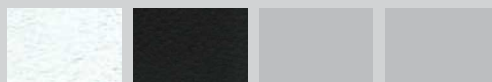

0 clear 4 dark grey

K rautovým schodům nabízíme skleněné podpěry podle velikosti schodů. Pro bližší informace nás prosím kontaktujte.

For STEPS Trays we also offer special glass supports according to the size of product. We can send further informations on request.



Podpěru je nutné doobjednat zvlášť.
Support must be ordered separately.

RAUTOVÉ SCHODY II. | STEPS II. TRAYS

Kód | Code **Rozměr | Size**

540x22 83 x 48 x 12 cm

x - Číslice určující barvu výrobku
x - Number of individual color

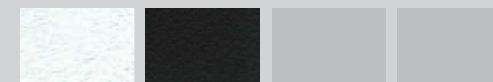

0 clear 4 dark grey

K rautovým schodům nabízíme skleněné podpěry podle velikosti schodů. Pro bližší informace nás prosím kontaktujte.

For STEPS Trays we also offer special glass supports according to the size of product. We can send further informations on request.



Podpěru je nutné doobjednat zvlášť.
Support must be ordered separately.



TÁCKY CANAPÉ IV. | CANAPÉ TRAYS IV.

Kód | Code Rozměr | Size

53351xx 10 x 10 cm

xx - Dvojcísli určující barvu výrobku
xx - Number of individual color



TÁCKY CANAPÉ V. | CANAPÉ TRAYS V.

Kód | Code Rozměr | Size

50112xx 7 x 7 cm

xx - Dvojcísli určující barvu výrobku
xx - Number of individual color



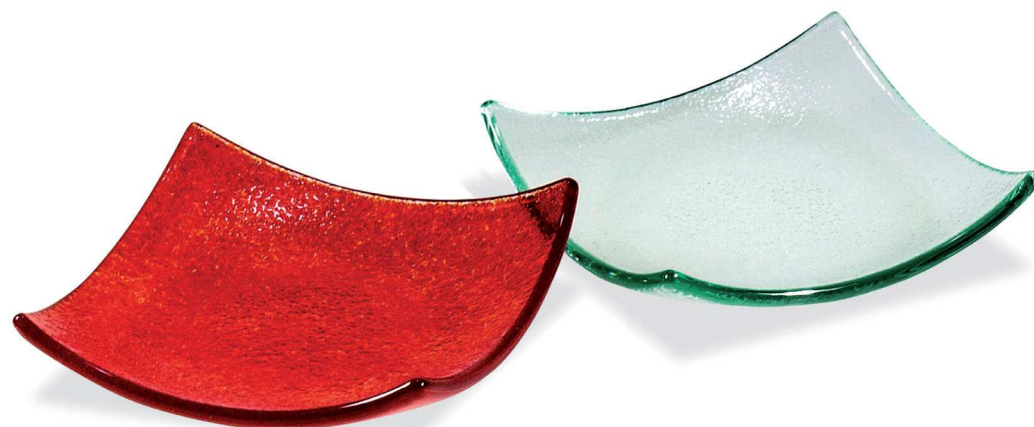

TÁCKY CANAPÉ II. | CANAPÉ TRAYS II.

Kód | Code **Rozměr | Size**

50101xx 8 x 6 cm

xx - Dvojcíslní určující barvu výrobku
xx - Number of individual color



TÁCKY CANAPÉ VII. | CANAPÉ TRAYS VII.

Kód | Code **Rozměr | Size**

50116xx 10 x 10 cm

xx - Dvojcíslní určující barvu výrobku
xx - Number of individual color





TÁCKY CANAPÉ VIII. | CANAPÉ TRAYS VIII.

Kód | Code Rozměr | Size

50117xx 18 x 5 cm

xx - Dvojčíslí určující barvu výrobku
xx - Number of individual color



MISKY ALADIN | ALADIN BOWLS

Kód | Code Rozměr | Size

50133xx 28 x 15 cm

xx - Dvojčíslí určující barvu výrobku
xx - Number of individual color





MISKY SOJA | SOJA BOWLS

Kód | Code **Rozměr | Size**

246001xx ø 6 cm hloubka 4,5 cm |
depth 4,5 cm

246002xx ø 7 cm hloubka 4,5 cm |
depth 4,5 cm

xx - Dvojcísíli určující barvu výrobku
xx - Number of individual color



01 red 02 green 03 blue 04 orange



19 violet 20 clear 22 dark grey 30 grey



MISKY WINKY | WINKY BOWLS

Kód | Code **Rozměr | Size**

50121xx ø 8 cm hloubka 3,5 cm |
depth 3,5 cm

50122xx 8 x 8 cm hloubka 4 cm |
depth 4 cm

50123xx 10 x 10 cm hloubka 5 cm
| depth 5 cm

xx - Dvojcísíli určující barvu výrobku
xx - Number of individual color

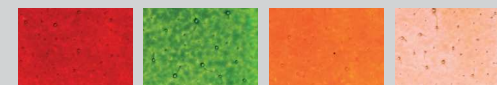

01 red 02 green 04 orange 07 beige



08 turquoise 09 pink 19 violet 36 light amber



30 grey 20 clear





ETAŽÉR NA DORT | CAKE WHATNOT

Kód Code	Rozměr Size
55125xx	ø 28 cm Výška hight 7 cm nebo or výška hight 12 cm
55126xx	ø 33 cm Výška hight 7 cm nebo or výška hight 12 cm

xx - Dvojcíslní určující barvu výrobku
xx - Number of individual color



ETAŽÉR VELO | VELO CAKE WHATNOT

Kód Code	Rozměr Size
55122xx	ø 22 cm Výška hight 7 cm nebo or výška hight 12 cm
55123xx	ø 28 cm Výška hight 7 cm nebo or výška hight 12 cm

xx - Dvojcíslní určující barvu výrobku
xx - Number of individual color

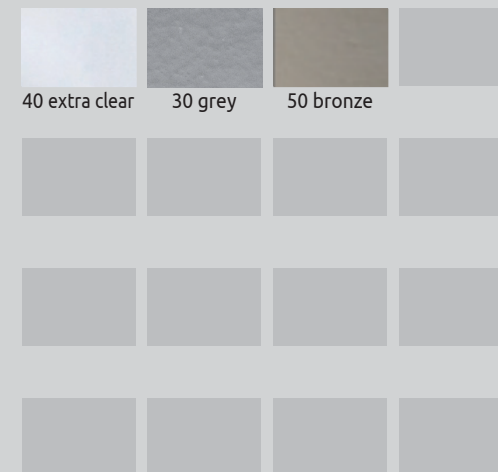



ETAŽÉR MATIZ | MATIZ CAKE 3-STOREY WHATNOT

Kód | Code **Rozměr | Size**

55121xx Talíře | Plates:
30 x 30 cm
20 x 20 cm
15 x 15 cm
Výška | Hight 28 cm

xx - Dvojcíslný určující barvu výrobku
xx - Number of individual color

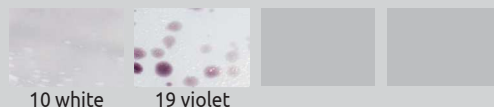

ETAŽÉR VELO | VELO CAKE 3-STOREY WHATNOT

Kód | Code **Rozměr | Size**

55120xx Talíře | Plates:
ø 32 cm
ø 25 cm
ø 20 cm
Výška | Hight 30 cm

xx - Dvojcíslný určující barvu výrobku
xx - Number of individual color



SVÍCNY | CANDLESTICKS

Candlesticks *Svícný*





SVÍCNY FLOWER | FLOWER CANDLESTICKS

Kód | Code **Rozměr | Size**

61x181 10 x 10 cm

610xxx 10 x 10 cm

x - Číslice určující barvu výrobku
x - Number of individual color

xxx - Trojčíslí určující barvu výrobku
xxx - Number of individual color

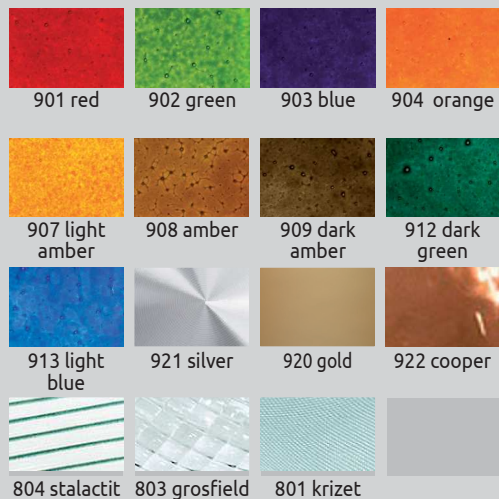

0 clear

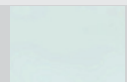

1 sanded



SVÍCNY FLY | FLY CANDLESTICKS

Kód | Code **Rozměr | Size**

54160xx 34 x 13 cm

xx - Dvočíslí určující barvu výrobku
xx - Number of individual color





SVÍCNY FLY LINKY | FLY LINKY CANDLESTICKS

Kód | Code Rozměr | Size

54160xx 34 x 13 cm

xx - Dvojčíslí určující barvu výrobku
xx - Number of individual color

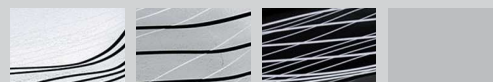

29 extra clear
with black and
silver lines

49 grey with
black and
silver lines

69 dark grey
with white
lines

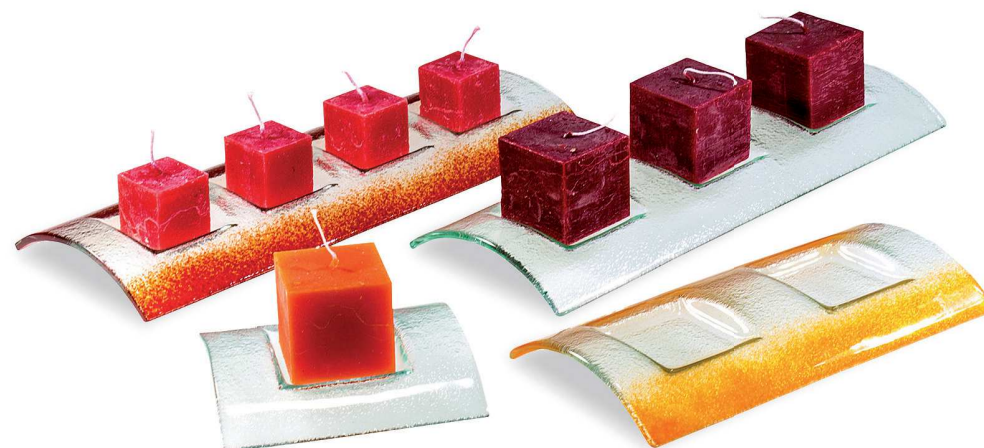

SVÍCNY TUNNEL | TUNNEL CANDLESTICKS

Kód | Code Rozměr | Size

65101xx 13 x 13 cm

65102xx 23 x 13 cm

65103xx 34 x 13 cm | 3 svíčky
3 candles

65104xx 34 x 13 cm | 4 svíčky
4 candles

xx - Dvojčíslí určující barvu výrobku
xx - Number of individual color



01 red

02 green

03 blue

04 orange



06 yellow

07 beige

08 turquoise

09 pink

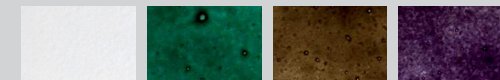

10 white

12 dark green

17 brown

19 violet



20 clear





SVÍCNY TUNNEL LINKY | TUNNEL LINKY CANDLESTICKS

Kód | Code **Rozměr | Size**

65101xx 13 x 13 cm

65104xx 34 x 13 cm

xx - Dvojičíslicí určující barvu výrobku
xx - Number of individual color



29 extra clear
with black and
silver lines

49 grey with
black and
silver lines

69 dark grey
with white
lines



SVÍCNY TRIANGLE | TRIANGLE BOWLS

Kód | Code **Rozměr | Size**

53810xx 20 x 20 x 20 cm

xx - Dvojičíslicí určující barvu výrobku
xx - Number of individual color



01 red

02 green

03 blue

04 orange

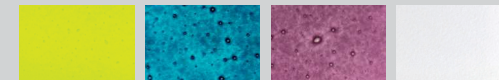

06 yellow

08 turquoise

09 pink

10 white



17 brown

19 dark violet

20 clear

21 sanded



36 light amber



SVÍČNY TRIANGLE LINKY | TRIANGLE LINKY BOWLS

Kód | Code Rozměr | Size

53810xx 20 x 20 x 20 cm

xx - Dvojcísli určující barvu výrobku
xx - Number of individual color



29 extra clear with black and silver lines

49 grey with black and silver lines

69 dark grey with white lines



SVÍČNY PALMER | PALMER CANDLESTICKS

Kód | Code Rozměr | Size

□□□ 54188xx 30 x 12 cm

□□□□ 54189xx 36 x 12 cm

xx - Dvojcísli určující barvu výrobku
xx - Number of individual color



01 red

02 green

03 blue

04 orange



06 yellow

08 turquoise

09 pink

10 white

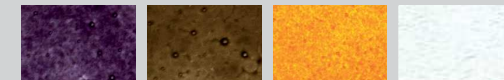

19 violet

17 brown

36 light amber

20 clear



30 grey

22 dark grey





SVÍCNY PALMER | PALMER CANDLESTICKS

Kód | Code Rozměr | Size

54183xx 27 x 10 cm

54184xx 33 x 10 cm

xx - Dvočíslí určující barvu výrobku
xx - Number of individual color



SVÍCNY LED TUNNEL | LED TUNNEL CANDLESTICKS

Kód | Code Rozměr | Size

56036xx 39 x 10 cm

xx - Dvočíslí určující barvu výrobku
xx - Number of individual color

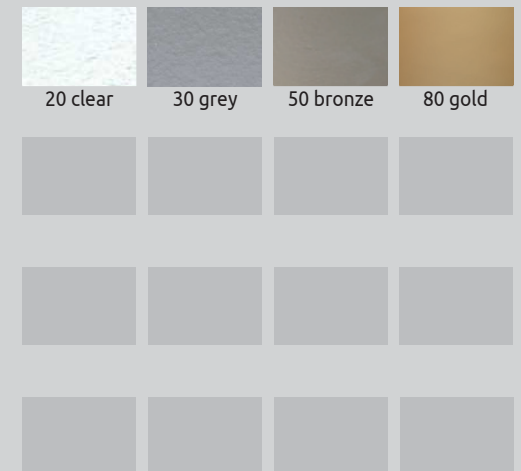

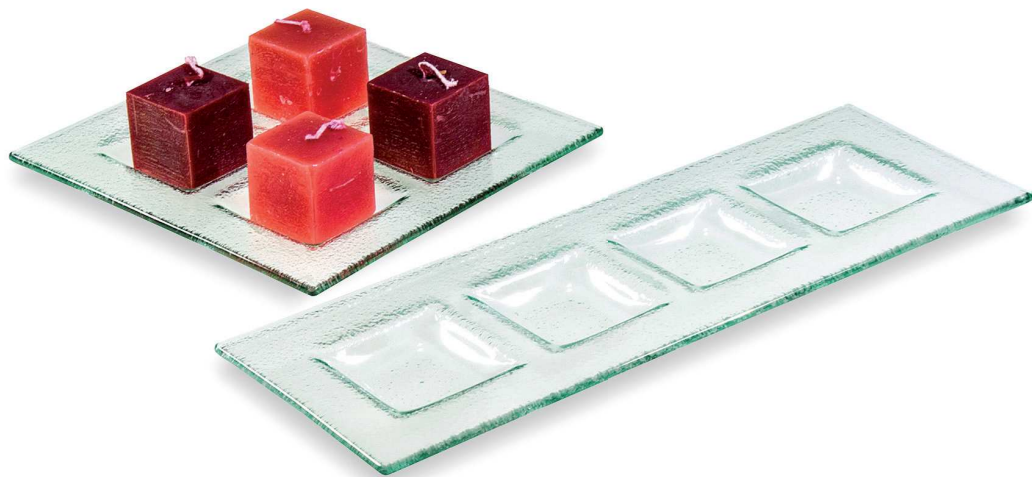

SVÍCNY ADVENT | ADVENT TRAYS

Kód | Code Rozměr | Size

5336x1 17,5 x 17,5 cm

5336x2 31,5 x 11 cm

x - Číslice určující barvu výrobku
x - Number of individual color



0 clear

1 grey



SVÍCNY BOAT | BOAT CANDLESTICKS

Kód | Code Rozměr | Size

64011xx 15 x 12 cm

64012xx 24 x 12 cm

64013xx 31 x 12 cm

xx - Dvojčíslí určující barvu výrobku
xx - Number of individual color



01 red

02 green

03 blue

04 orange



06 yellow

07 beige

08 turquoise

09 pink

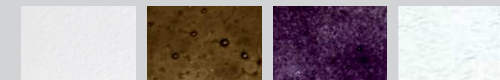

10 white

17 brown

19 violet

20 clear



22 dark grey





SVÍCNÝ ANGEL | ANGEL CANDLESTICKS

Kód Code	Rozměr Size
223010xx	výška height: 12 cm křídla nahoru wings up bílé šaty white dress
223015xx	výška height: 14 cm křídla dolů wings down bílé šaty white dress
223013xx	výška height: 12 cm křídla nahoru wings up barevné šaty color dress
223018xx	výška height: 14 cm křídla dolů wings down barevné šaty color dress

xx - Dvojičíslo určující barvu výrobku
xx - Number of individual color

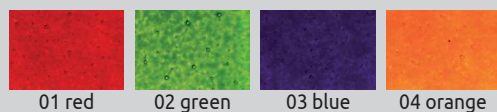

SVÍCNÝ LEAF | LEAF CANDLESTICKS

Kód Code	Rozměr Size
61040xx	8 x 9 cm
61041xx	12 x 17 cm
61042xx	15 x 16 cm
61031xx	18 x 8,5 cm
61030xx	12 x 8,5 cm
61032xx	30 x 10 cm

xx - Dvojičíslo určující barvu výrobku
xx - Number of individual color

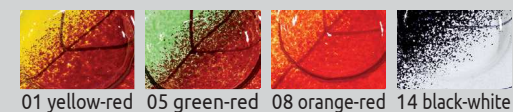



SVÍČNY FISH | FISH CANDLESTICKS

Kód Code	Rozměr Size
61051xx 17 x 8 cm	
61052xx 23 x 9 cm	
61053xx 30 x 10 cm	

xx - Dvojčíslí určující barvu výrobku
xx - Number of individual color

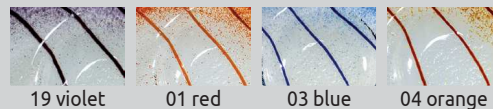

SVÍČNY COSMOS | COSMOS CANDLESTICKS

Kód Code	Rozměr Size
5248xx	ø 29 cm
5247xx	ø 18 cm

xx - Dvojčíslí určující barvu výrobku
xx - Number of individual color

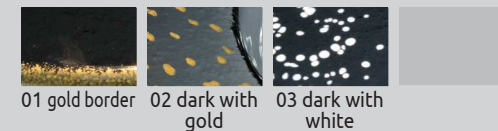



SVÍCNÝ VLOČKA | SNOWFLAKES CANDLESTICKS

Kód | Code **Rozměr | Size**

51540xx 10 x 10 cm

xx - Dvojčíslí určující barvu výrobku
xx - Number of individual color



03 dark grey
with white



04 clear with
white



SVÍCNÝ CANDY | CANDY CANDLESTICKS

Kód | Code **Rozměr | Size**

515401xx 10 x 10 cm

xx - Dvojčíslí určující barvu výrobku
xx - Number of individual color

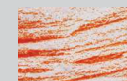

01 red

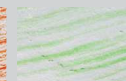

02 green



04 orange



08 turquoise



10 white

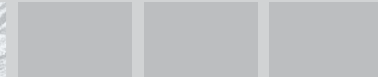



SVÍČNY LEAF DECAL | LEAF DECAL CANDLESTICKS

Kód Code	Rozměr Size
61061xx 16 x 8 cm	
61062xx 19 x 10 cm	
61063xx 28 x 13 cm	

xx - Dvojcíslní určující barvu výrobku
xx - Number of individual color

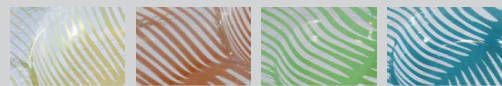

01 gold 02 african brown 03 green 04 turquoise



4-POZICOVÉ SVÍČNY FLY | 4 POSITION FLY CANDLESTICKS

Kód Code	Rozměr Size
54162xx	38 x 13 cm

xx - Dvojcíslní určující barvu výrobku
xx - Number of individual color



29 extra clear with black and silver lines 49 grey with black and silver lines 69 dark grey with white lines 50 clear with colored spots



60 grey with colored spots





DEKORACE | DECORATIONS
Decorations *Dekorace*



DEKORATIVNÍ ANDĚLÉ | DECORATIVE ANGELS

Kód Code	Rozměr Size
111300100	12 x 20 cm - A
111300300	13 x 25 cm - C

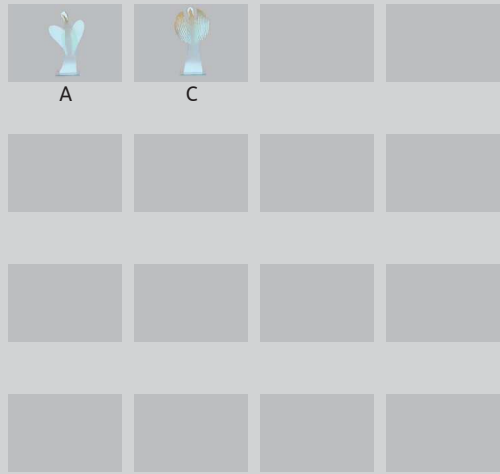

DEKORATIVNÍ KOČKY | DECORATIVE CATS

Kód Code	Rozměr Size
11101x1	16 x 8 cm - A
11101x2	20 x 12 cm - B
11101x3	13 x 14 cm - C
11101x4	10 x 14 cm - D
11101x5	8 x 22 cm - E
11101x6	8 x 20 cm - F

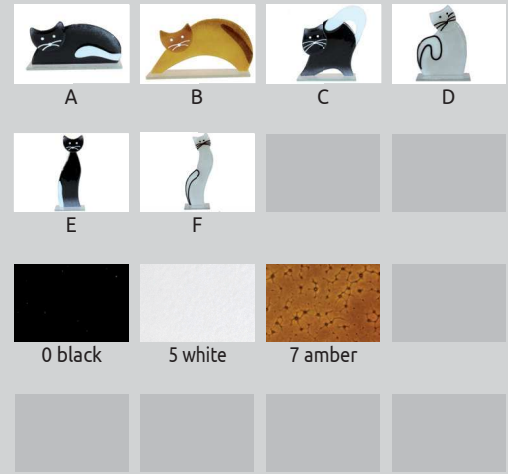

x - Číslice určující barvu výrobku
x - Number of individual color





MÍSY NET | NET BOWLS

Kód | Code Rozměr | Size

5082xx 20 x 20 cm

5083xx 30 x 30 cm

xx - Dvojičíslo určující barvu výrobku
xx - Number of individual color

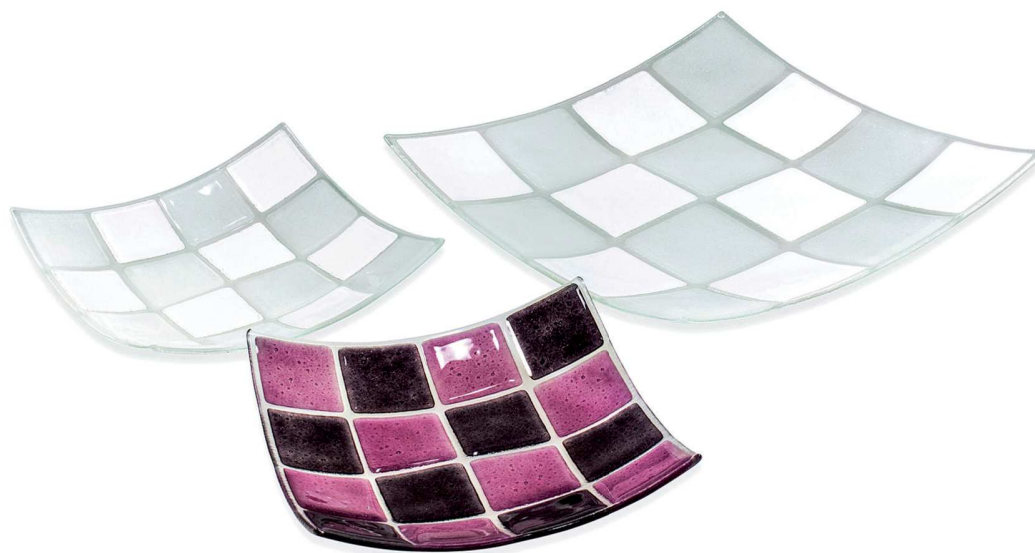

MÍSY KARO | KARO BOWLS

Kód | Code Rozměr | Size

5143xx 15 x 15 cm

5142xx 20 x 20 cm

5141xx 30 x 30 cm

xx - Dvojičíslo určující barvu výrobku
xx - Number of individual color

